

ARU 700, ARU 1200 & ARU 2100

(115/230 VOLT)

User's Manual

- **Installation**
- **Operation**
- **Maintenance**

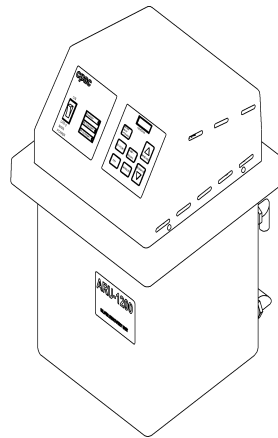

TABLE OF CONTENTS

RECOMMENDATIONS	4
IMPORTANT SAFEGUARDS	4
DESCRIPTION	5 - 6
Items Included in Shipping Container	5
Automatic Terminal Electrolytic Silver Recovery	6
Efficient Recovery Automatically Matched to Your Needs	6
SPECIFICATIONS	7
CONTROLS	8 - 9
Figure 1-ARU Control Panel	8
LED Digital Display	8
Keypad	8
Status Lamps	9
INSTALLATION AND SET-UP	9 - 11
Connecting Unit to the Processor	10
Programming the ARU	11
Table 1	11
OPERATIONS	12-16
Table 2	12
Amp-Hours Key	13
Fail Safe Procedure	14
Set Point	14
Background Information	14
Effects	15
Changing the Point Setting	15
Cell Voltage Measurement	16
Volume Count (optional)	16
DESILVERING CATHODE	17
Desilvering Cathode by User	17
MAINTENANCE AND SERVICE	18-19
Preventative Maintenance	19
Regular Cleaning and Inspection	19
TROUBLE SHOOTING GUIDE	20 - 21
SCHEMATICS	22 - 26

SPARE PARTS LIST	27 - 29
DISCLAIMER	30
STATEMENT OF WARRANTY	31

RECOMMENDATIONS

Read the entire instruction manual *before* installation or operation of the ARU-700, ARU-1200 and ARU-2100 silver recovery system. It will help you to understand the operation of the system, how various sub assemblies work together, and the operating sequence of the controls.

WARNING: NEVER ATTEMPT TO PERFORM ANY ELECTRICAL TROUBLESHOOTING ADJUSTMENT(S) OR SERVICE(S) UNLESS YOU ARE A QUALIFIED ELECTRICIAN, ELECTRONICS TECHNICIAN, OR FACTORY TRAINED SERVICE TECHNICIAN.

IMPORTANT SAFEGUARDS

When using your ARU-700, ARU-1200, and ARU-2100 silver recovery systems, these basic safety precautions should be followed:

1. Read and understand all instructions.
2. Care must be taken to avoid burns from touching hot parts.
3. Do not operate this appliance with a damaged cord or if the appliance has been dropped or damaged until it has been examined by a qualified service technician.
4. Do not let power cord hang over edge of table or counter or touch hot surfaces.
5. An extension cord should not be used with this unit. The unit should be plugged directly into a power outlet.
6. To protect against electrical shock hazard, do not immerse this appliance in water or other liquids.
7. To avoid electrical shock hazard, do not disassemble this appliance. Call a qualified service technician when service or repair work is required. Incorrect reassembly can cause electric shock hazard when the appliance is switched on.

SAVE THESE INSTRUCTIONS

DESCRIPTION

General Comments

The ARU-700, ARU-1200, and ARU-2100 silver recovery units are designed to remove silver electrolytically from photographic fixer solution. These compact efficient units are manufactured from the finest materials and components, thus insuring many years of reliable trouble-free operation.

Items Included in Shipping Container

1. Power head assembly, including:
 - a) plating power supply
 - b) motor drive
 - c) cathode drum
 - d) electrical cord
 - e) PCB with microprocessor and digital display
 - f) keypad controls

2. Complete tank assembly, including:
 - a) factory installed fittings
 - b) drain tubing
 - c) tidy tray
 - d) four carbon anodes
 - e) anode/cathode support

3. Hook-up kit:
 - a) one PVC coupling $\frac{3}{4}$ " x $\frac{3}{4}$ "
 - b) one PVC reducer $\frac{3}{4}$ " x $\frac{1}{2}$ "
 - c) 10' of $\frac{3}{4}$ " tubing
 - d) hose clamps (2)

4. Information kit:
 - a) instruction manual and spare parts price list
 - b) silver test paper
 - c) warranty registration card

Automatic Terminal Electrolytic Silver Recovery

The ARU silver recovery units are automatic. They control and optimize plating current as the silver concentration varies in the fixer solution. These units automatically increase plating current during peak periods to recover all the silver possible, and reduce plating current during slow periods to reduce sulfiding. The ARU units eliminate the need for separate timers, fussy “wiring into the film processor”, or worry about turning the unit OFF at night or weekends, and ON again in the morning. The microprocessor regularly samples the silver concentration of the fixer solution and automatically adjusts the plating current to match the working schedule and actual silver recovery needs.

Efficient Recovery Automatically Matched to Your Needs

Since the ARU series automatically adjust their recovery rates to match silver “production”, loss of precious silver to the drain is minimized. These units do not require a timer, thus avoiding problems caused by timer schedules being disrupted by power outages. These units also avoid loss of silver if emergency film is processed during an “off” period. These units do not require separate probes or reference solutions, thus avoiding frequent maintenance checks and solution calibration. Terminal silver recovery units that use special probes often require frequent calibration with a reference solution or cleaning of a sensing probe, and are often out of calibration, resulting in loss of silver. The ARU series use a simple and unique method of regularly measuring the silver concentration of the fixer solution. The sensing system is completely self-contained in this unit and does not use sensitive probes or reference solutions.

SPECIFICATIONS

General Comments

Recovery Capacity	ARU-700	0.83 Troy oz./hr. (25.8 grams/hr.)
	ARU-1200	1.43 Troy oz./hr. (44.3 grams/hr.)
	ARU-2100	2.5 Troy oz./hr. (77.5 grams/hr.)
Plating Range	ARU-700	1 - 7
	ARU-1200	1 - 12
	ARU-2100	1 - 21
Dimensions	ARU-700/1200	15"D x 15"W x 20 ^{3/8} "H (38cm x 38cm x 52cm)
	ARU-2100	15"D x 15"W x 26 ^{5/8} "H (38cm x 38cm x 68cm)
Tank	ARU-700/1200	5.0 gal. (19 liters)
	ARU-2100	9.0 gal. (34 liters)
Electrical	115/230 VAC, 50/60 Hz	
	ARU-700	75 Watts
	ARU-1200	90 Watts
	ARU-2100	105 Watts
Net Weight	ARU-700	30 lbs. (14 kilograms)
	ARU-1200	33 lbs. (15 kilograms)
	ARU-2100	38 lbs. (18 kilograms)
Shipping Weight	ARU-700	40 lbs. (18 kilograms)
	ARU-1200	43 lbs. (19 kilograms)
	ARU-2100	49 lbs. (22 kilograms)
Materials of Construction	Tank - Polyethylene, Electrical shroud ABS Plastic, Cathode - Stainless Steel Anode - Carbon	
Installation	Unit is internally pre-plumbed. Complete with all fittings.	

CONTROLS

Front Panel of Silver Recovery Unit

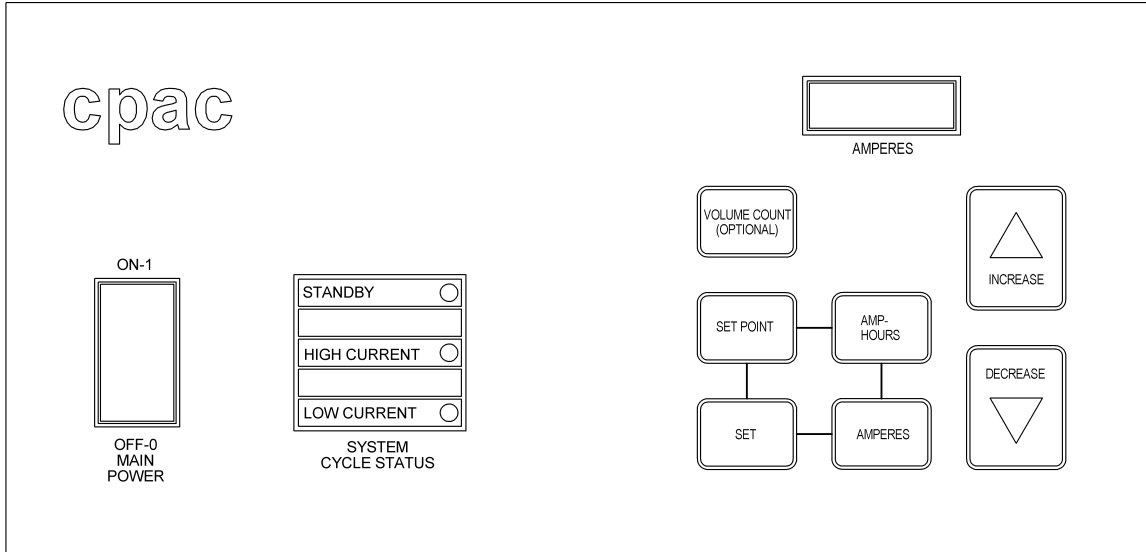

LED Digital Display

Amperes

This display shows the present plating current.

Keypad

Control

Function

Volume Count (optional)

Will display the number of liters of fixer replenishment used (feature only works if current ring is installed).

Set Point

Will display the set point calibration number.

Amp-Hours

Will display the current amp-hours timer, and then the units lifetime amp-hours timer.

Set

Pushing this key activates an indicator light behind the key. When the light is on- the operator can make permanent changes to the set point and amperage settings.

Amperes

Pushing once will display the high current amps and pushing again will display low current amps.

Increase/Decrease

These keys are used to set the values of various system functions.

Status Lamps

Control	Function	Operation
Standby	The unit is idle. It will start desilvering when the 15 minute stand-by timer expires.	Lamp is lit in STAND-BY mode only.
High Current	The unit is desilvering at the high current setting.	Lamp is lit in high current cycle, and in sampling cycle after a high current cycle.
Low Current	The unit is desilvering at the low current setting.	Lamp is lit in low current cycle, and in sampling cycle after a low current cycle.

INSTALLATION AND SET-UP

General Comments

1. Remove the ARU from shipping container and check for signs of damage such as cracked tanks, broken fittings, etc. Notify CPAC immediately if any damage exists. Remove all packing materials including the packing between the cathode and anodes and save.
2. Position the system three to four feet from a grounded 120 VAC, 2 Amp power source. (230 VAC 1 Amp power source for export units). Check the rating plate label for the voltage.
3. Drain provisions must be provided for the unit as well as other accessories used.
4. Connect the safety overflow hose to a drain.
5. Connect the silver bearing overflow hose from the processor(s) to either a solution collecting tank or directly to the ARU tank inlet.

CAUTION: Use hose clamps on all connections to prevent leaks.

Connecting Unit to the Processor

1. Place the silver recovery unit in a convenient location within easy access to a drain and a 115/230 VAC grounded electrical supply.
2. Inspect all bulkhead fittings (inlet, outlet, drain) on ARU tank to insure tightness.
3. Securely attach ARU inlet tubing to the processor's fixer overflow connection.

CAUTION: Severe bends and kinks in tubing will result in blockage of flow. For your convenience, a tubing hook-up kit consisting of one PVC 3/4" x 3/4" coupling and one PVC 3/4" x 1/2" reducer has been provided.

4. Place ARU outlet tubing in the nearest chemical resistant drain to the sewer. (In any event, conform to prevailing local ordinances.) If the sewer drain is higher than the ARU outlet, place the unit on a stand, which elevates the outlet above the sewer drain.
5. Fill the ARU tank with silver-laden fixer to the level of the outlet fitting.
6. ARU units are available as 115 or 230VAC. Be sure the power supply matches the voltage requirement of the unit (the voltage requirement is printed on the back of the powerhead). Plug the ARU power cord into 115/230 VAC electrical outlet, which is properly grounded. Some processors have 115/230 VAC accessory electrical outlets, which may be used.
7. Turn the unit ON.

Programming the ARU

1. The various ARU units are factory programmed as indicated in Table 1 below. All of these parameters can be changed and other values reprogrammed into the unit.

TABLE 1
Factory Settings

Model	Set Point	High Current (A)	Low Current (A)	Fixer Replenishment Rate (ml /min.)
ARU-700	30	5	2	250
ARU-1200	30	8	3	250
ARU-2100	30	13	6	250

2. To reprogram the unit, use the following keys. Their functions are described below:

SET: Press this key to enter the programming mode. The display will go blank. A light in the upper right corner of the key glows indicating that the microprocessor is in the "SET" mode and values can now be changed.

SET POINT: Pressing this key will cause the set point to be displayed and flashed, which indicates that it can be changed. Change this setting by using the INCREASE or DECREASE key. See the section on OPERATION for a detailed explanation of this setting.

AMPERES: Pressing this key once will cause the high current setting to be displayed and flashed (i.e. H 10), which indicates that it can be changed. Change this setting by using the INCREASE or DECREASE key. Pressing this key again will cause the low current setting to be displayed and flashed (i.e. L 5). Change this setting by again using the INCREASE or DECREASE key. In order to toggle back and forth between the two current settings, continue to press this key. The microprocessor will prevent the operator from programming the high and low current settings too close to each other in order to ensure proper operation. The two settings cannot be less than 3 amps apart for the ARU-700, 5 amps apart for the ARU-1200, and 7 amps apart for the ARU-2100.

3. When using the INCREASE or DECREASE key, each time the arrow is pressed, the value will change by one. Holding down an arrow will change the value rapidly after an initial delay of about one second. Use this rapid change to get near the aim value and then use individual pushes until the exact value is reached.
4. When all programming is complete, press the SET key. The light in the upper right corner of the key will go out, and the new values entered into the microprocessor. Note that it is not mandatory to make all the above changes before pressing this key. New parameters can be entered into the system at any time by pressing the SET key.

OPERATIONS

General Comments

The ARU silver recovery unit follows a pattern of desilvering, sampling and standby cycles in order to constantly monitor the silver concentration and adjust the current (amperage) accordingly.

The desilvering cycle lasts for three (3) minutes during which time the unit will be plating silver in either high or low current mode. At the end of each desilvering cycle, the unit enters a sampling cycle that lasts for 15 seconds.

At the end of the sampling cycle, the microprocessor measures the cell voltage to determine whether the unit will start another desilvering cycle or enter a standby cycle. If the ARU unit enters a standby cycle, desilvering is halted for fifteen (15) minutes, at the end of which it starts up again.

The first desilvering cycle after the unit is initially turned on and also after a standby cycle, is in low current for 1.5 minutes instead of the normal 3 minutes. This feature limits the amount of desilvering time if no silver-laden fix is added for an extended period of time (i.e. overnight or over the weekend).

The microprocessor will force a desilvering cycle into low current mode, whenever the temporary AMP-HOURS timer is below the value as indicated in Table 2 below.

This feature allows a bare cathode to buildup a solid base of silver and also eliminates the changes a bare cathode has on the setpoint calibration. See the section on the AMP-HOURS key for more details on utilizing this feature by resetting the temporary amp-hours timer every time the cathode is desilvered.

TABLE 2

Minimum Value of Temporary Amp-Hours Timer

Model	Amp-Hours (A-hrs.)
ARU-700	4
ARU-1200	6
ARU-2100	12

AMP-HOURS Key

The AMP-HOURS key enables the operator to monitor the recovery rate of the unit. There are two amp-hours timer values that the microprocessor keeps stored in its memory.

The first is the temporary amp-hours timer, which is resettable, and should be reset to zero every time the cathode is desilvered. This will enable the operator to monitor how much silver has plated on the cathode assuming an average recovery efficiency, and will also enable the low current initial plating feature. In order to reset the temporary amp-hours timer, press and hold down both the AMP-HOURS and DECREASE keys until the 5 second reset timer on the display counts down to zero.

The value of the temporary amp-hours timer can also be used to calculate the recovery efficiency of the unit. This can be done by performing the following steps:

1. Calculate the troy-ounces (or grams) of silver plated at 100% efficiency by taking the number of temporary amp-hours since the cathode was last desilvered and multiply by 0.128 (multiply by 4 to calculate grams of silver plated).
2. Weigh the troy-ounces (or grams) of silver recovered from the cathode after desilvering.
3. Divide the value in Step 2 by the value in Step 1, and then multiply by 100 to calculate the recovery efficiency percentage (%).
4. If the recovery efficiency calculated in Step 3 is less than 80% the unit is operating too long in desilvering mode with no silver left in solution, and indicates the set point is too high. Lower the set point as described in the section "Programming the ARU".

The second value the unit keeps track of is the permanent amp-hours timer, which is non-resettable and therefore equals the number of amp-hours during the lifetime of the unit.

Press and hold down the AMP-HOURS key to view the value of the two timers. The temporary amp-hours timer is displayed for the first 4 seconds and the permanent amp-hours timer is displayed thereafter. If either timer exceeds 10,000 the value will be displayed exponentially. The integer base will be displayed for 2 seconds and then the base 10 exponent (i.e. 26,500 -> base display = 2650 and exponent display = E1). The base exponent is the number of zeros added to the end of the integer base to obtain the timer value.

Fail Safe Procedures

Internally the microprocessor continually checks for mechanical and/or electrical problems. Any problem affecting the plating action will be detected. The digital display will show "ERR 1" if the unit cannot reach the programmed amperage. The display will then show in sequence, "ERR 1/LO-A". This could be caused by the desilvering tank not filled, too low silver content of the chemicals, electrical connections not clean, etc. The message will continue to show until the problem is corrected. When a problem, such as a broken wire is corrected, the desilvering cycle will begin where it left off.

SET POINT

The set point is displayed as a range of 0 to 60 (factory default = 30). Each increment is equal to 10 mV, 0 = 300 mV, 30 = 600 mV, and 60 = 900 mV. The ARU system actually works with two set points, the set point that can be adjusted and displayed is the HIGH set point, the LOW set point is automatically calculated to be 50 mV less than the HIGH set point.

Background Information

There is a relationship between plating current and silver concentration in the electrolyte (silver bearing fixer solution) of the silver recovery unit. When a large quantity of silver is present in the fixer, there is less resistance between the anode and cathode, which results in a lower plating voltage. As the silver is removed from fixer, more resistance occurs between the anode and a higher plating voltage will be required to maintain the plating current setting.

The ARU control PCB uses the anode and cathode as a sensor. Every three minutes (desilvering cycle), the unit stops plating for fifteen seconds (sampling cycle) and measures its own cell voltage. If the measured cell voltage is below the LOW set point, the silver recovery unit will plate on the HIGH current setting. When the cell voltage is equal to or above the LOW set point and below the HIGH set point, the unit will plate on the LOW current setting. If the cell voltage is equal to or above the HIGH set point, the unit will cease plating and enter the standby cycle.

For example:

HIGH Set Point	LOW Set Point	Cell Voltage Measured in Silver Recovery Unit	Plating Current
I 600 mV (30)	550 mV (25)	500 mV (20)	High
II 600 mV (30)	550 mV (25)	550 mV (25)	Low
III 600 mV (30)	550 mV (25)	600 mV (30)	Standby

Effects

Higher set point settings will keep the unit operating on high plating current more, and take silver concentration to a lower level. *Too high a setting will cause sulfiding.*

Lower set point settings will give harder plate and keep the unit operating on low plating current more. *Too low a setting will result in silver being lost to drain.*

Generally, the correct set point setting will plate silver on the cathode that is typically dark brown to light gray in color and granular in texture.

Changing the Set Point Setting

The set point is a calibration number that determines how much silver is removed from the chemistry. If the unit is not removing enough silver, the set point should be raised. If it is removing too much silver, the set point should be lowered. It is not practical to change the calibration during installation because the calibration will change after the cathode has an initial coating of silver. Also, the unit will plate the initial coating of silver in low current mode only, so changing the set point during installation will have no effect until the minimum temporary amp-hours value listed in Table 2 is reached. It is recommended that the set point be left at the factory setting unless the plating is not satisfactory after the cathode has a coating of silver.

To make a change to the set point:

1. Let the unit plate for several cycles as it is.
2. Press the SET POINT and AMP-HOURS keys. The value shown on the digital display reflects the silver level from the last sample period. Record this value.
3. Press the SET POINT key. The current set point will be displayed on the digital. Record this value.
4. The value from Step 3 is compared to the value from Step 2 to determine the plating mode that will be selected.
 - If the value from Step 2 is greater than, or equal to, the value from Step 3 - the unit will go into STANDBY.
 - If the value from Step 2 is 6 or more below the value from Step 3 - the unit will plate in HIGH current.
 - If the value from Step 2 is less than the value from Step 3, but is not 6 or more below the value from Step 3 - the unit will plate in LOW current.

Change the set point setting in order to adjust the calibration point at which the recovery unit will switch plating cycles (High, Low and Standby). The recommended increase or decrease in the set point at any one time is 1 or 2 (10 or 20 mV), and should be based on analysis of several samples recorded in Step 2 above.

Cell Voltage Measurement

The cell voltage is constantly being measured by the PCB and can be viewed in millivolts on the display as long as both the INCREASE and DECREASE keys are pressed at the same time. This feature is useful in determining whether the plating power supply is providing a DC voltage source to the recovery cell.

For extensive trouble shooting, the cell voltage can be displayed without having to hold down the INCREASE and DECREASE keys by first pressing the SET key to enter the programming mode. Next, briefly press the INCREASE and DECREASE keys at the same time to display the cell voltage. Press the SET key again to exit the programming mode and the display will return to showing the amperage.

Volume Count (optional)

The volume count feature allows the user to program the fixer replenishment pump rate (in ml/min.) into the microprocessors memory, and then utilize a current ring (current sensing device) to monitor the run time of the replenishment pump. These two valves will be used to calculate the fixer replenishment volume or volume count.

The volume count measured in liters is a re-settable counter, which can be viewed on the display by pressing the VOLUME COUNT key. In order to reset the volume count back to zero, press and hold both the VOLUME COUNT and DECREASE keys until the 5 second reset timer on the display counts down to zero.

Program the fixer replenishment pump rate in ml/min. by first pressing the SET key to enter the programming mode. Next, press the VOLUME COUNT key and the current pump rate setting will be displayed and flashed. Use the INCREASE or DECREASE keys to change the setting. Finally, press the SET key again to exit programming mode and store new setting in microprocessor's memory.

The optional current ring is clamped on one of the electrical wires to the fixer replenishment pump. It can be connected around either the hot or the neutral wire, but only one wire goes through the ring of the current sensor. Follow the unit schematic to connect the current ring signal wires if the current ring was not factory installed. The current ring will send a low voltage signal to the PCB whenever the pump is on.

The replenisher pump must draw .5 amps for the current sensor to work correctly. If the pump does not draw this much current, simply loop the electrical wire from the replenishment pump through the ring several times.

DESILVERING CATHODE

General Comments

Ideally, wait until you have recovered approximately 6 to 10 pounds of silver on the SRU cathode ($1/2$ to $3/4$ inch build-up) before stripping the silver. To remove the silver, follow these steps:

Desilvering Cathode by User

1. Equipment required:
 - a) $1/2$ inch wrench
 - b) putty knife, approximately one inch wide
 - c) large plastic bag (Optional)
2. Unplug unit.
3. Lift the top half of the unit (power head and cathode) straight up from the tank. The silver-laden cathode is attached to the bottom of the powerhead. Set the top down on a flat surface, preferably on a piece of plastic, or in a shallow pan, to catch fixer drips.
5. To remove cathode, loosen the hex head bolt on the coupling with standard $1/2$ " wrench. Power head will easily separate from silver-laden cathode.
5. With a putty knife or similar tool, scrape the silver from cathode. Experience has shown that it may be cleaner and more convenient if you put the cathode in large plastic bag during scraping.
6. Reinstall the cathode by inserting it into the cathode coupling; securely tighten the coupling bolt, and replace power head on tank.
7. To insure proper and continuing operation, check all hoses for possible leaks, kinks and to be sure that outlet hose is in the appropriate drain to sewer.

MAINTENANCE AND SERVICE
(TO BE DONE ONLY BY A QUALIFIED TECHNICIAN)

General Comments

1. Unplug unit from wall power.
2. Remove housing cover by taking out two screws on each side of the cover. Remove four screws in the corners of the large aluminum plate. Remove cathode contact brush lead from shunt. Lift entire electrical assembly straight up (by pulling up on the motor).
3. You are now looking at the tank cover complete with the motor coupling, contact brush spring, and bracket. This is a primary area of lost amperage. Check the set screw holding the bronze motor coupler onto the cathode drive shaft. Remove the motor coupler and the stainless steel cathode drive shaft. Clean these parts thoroughly inside and out. Inspect the plastic rulon bearing and the teflon seal. Replace if worn.
4. Reassemble, using a generous amount of grease between the rulon bearing and the teflon seal. Make sure the stainless steel washer is installed between the bronze motor coupling and the flanged rulon bearing. If this washer is not installed, the flanged bearing will wear excessively. When reassembling, be sure the set screw is tight – it must dig into the shaft. Allow approximately .020 end play between the cathode drive shaft and bearing (.020 thickness is approximately the thickness of a business card). Refer to Drawing 699601 for a detailed drawing of assembly.
5. Clean the contact brush. A small burr or particle can cut amperage substantially.
6. Replace the electrical assembly. Reconnect cathode contact brush lead to current shunt and tighten nut securely. Replace the four screws in the corners of aluminum plate.
7. Check all DC electrical connections. These connections must be perfect, clean and very tight.
8. Check hoses and bulkhead fittings to see that there are no leaks or restrictions.
9. Check lock washers, anode bolts and nuts. Remove any corroded washers. Replace corroded bolts.
10. Tighten all anode bolts.
11. Check, clean, and tighten ground wire terminal connection at ground strap.
12. Replace the power head and housing cover.
13. Plug unit into the power outlet. Turn unit ON

Preventive Maintenance

The moving parts of the ARU units are designed and built so they do not need frequent lubrication. The flanged sleeve bearing in the tank cover hub and the gear motor never need to be lubricated after they leave the factory.

Regular Cleaning and Inspection

This is very IMPORTANT. Keep the unit clean by using a rag dampened with “Spic-N-Span” (or similar household cleaner). Pay particular attention to cleaning the area of the anode brackets since these brackets will corrode if fixer comes in contact with them. (Corrosion can result in lower plating efficiency.)

Visually check the status LED's and digital display to insure that the unit is working properly and the power is ON.

Yearly, or when unit is moved from place to place, check plumbing for signs of leaking, restrictive kinks, etc.

A qualified technician should check all electrical screw-attached points for good conductivity, such as the ground wire. An especially important point to check is the set screws in the bronze motor coupling and cathode drive shaft to make sure they are tight.

TROUBLE SHOOTING GUIDE

SYMPTOMS	POSSIBLE CAUSE	PROBABLE SOLUTION
Fixer leak or crystallizing around inlet, outlet or drain fitting.	Loose bulkhead fitting or tubing.	Tighten fittings or tubing joints. For very bad leaks, remove and clean fittings. After cleaning, securely reinstall fittings to hold tank.
	Cracked fitting.	Replace fitting.
Fixer overflowing top of tank.	The drain opening to sewer is higher than ARU outlet, preventing solution from gravity feeding to sewer drain.	Put silver recovery unit on a stand so its' drain outlet is higher than sewer drain opening.
	Outlet tubing has a kink or blockage.	Straighten tubing and/or kink.
Motor not running and or all status LED's not lit.	Unit incorrectly installed and not getting power.	Check electrical source
	Blown fuse.	Investigate and remedy cause. Replace fuse.
	Unit not turned ON.	Turn power supply ON.
	Cathode grossly overloaded with silver.	Remove silver from cathode.
	Capacitor burned out.	Replace capacitor.
	Motor burned out or gears malfunctioning.	Replace motor.
Low or no cell current.	Fixer corroded anode bracket.	Replace anode ground bracket.
	Anode ground wire loose or not connected.	Connect.
ERR 1/LO-A flashing on display.	Anode carbon mount screws loose.	Tighten.

SYMPTOMS	POSSIBLE CAUSE	PROBABLE SOLUTION
Low or no cell current.	Cathode not securely fastened to power head.	Securely tighten cathode coupling screw to power head.
ERR 1/LO-A flashing on display.	Set screw holding motor coupler to cathode coupling has loosened.	Tighten set screw in motor coupler.
	Cathode contact brush worn out.	Replace cathode contact brush.
Sulphiding (rotten egg smell coming from silver recovery unit)	Unit has been ON for too long a period of time. All of the silver has been removed from fixer.	Lower set point and or current settings.
Silver falling off cathode.	Recovery unit ON too long.	Check electrical source
	Recovery from bleach-fix.	Unit won't recover silver from bleach fix.
	Cathode contaminated with grease and or oil.	Clean cathode with clean cloth and scouring powder (comet, etc.) and water; rinse thoroughly in water to remove contaminates.
No silver collecting on cathode.	Solution is not fixer.	Use silver laden fixer.
	No silver in fixer.	Use silver laden fixer.
ON/OFF switch ON, no power.	Blown fuse.	Investigate and remedy cause, replace fuse.

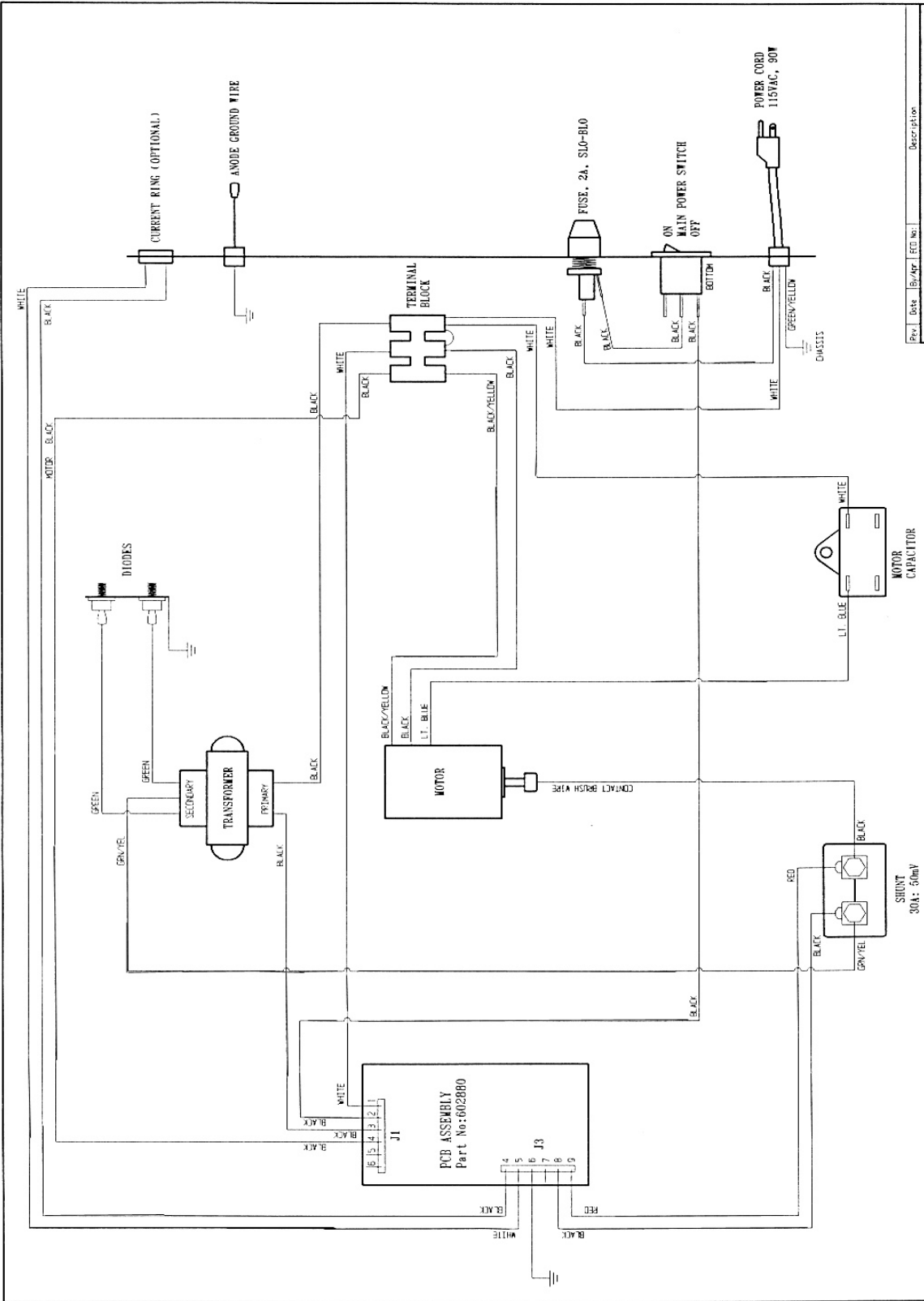

Proj.	Date	Rev.	ECN No.	Description
CPAC, INC. 2364 Leicester Road, Leicester, N. Y. 14881 Phone: (716) 362-3223 / Fax: (716) 362-3011				
Scale	Drawn By	Checked By	Approved By	Date
1:1	JC	JC	JC	11/5/99
Title: ARU-1200 UNIT ELECTRICAL SCHEMATIC				
For Products: 115 VAC				
Drawn: JC				
Sheet: 1 of 1				
Part No: 500325				

DIMENSIONS UNLESS OTHERWISE SPECIFIED	
UNITS	INCHES
DECIMALS	0.0004
FRACTIONS	1/32
ANGLES	1/16
PLACES	3
UNITS	MILLIMETERS
DECIMALS	0.0254
FRACTIONS	1/16
ANGLES	1/16
PLACES	3
UNITS	MILLIMETERS
DECIMALS	0.0254
FRACTIONS	1/16
ANGLES	1/16
PLACES	3

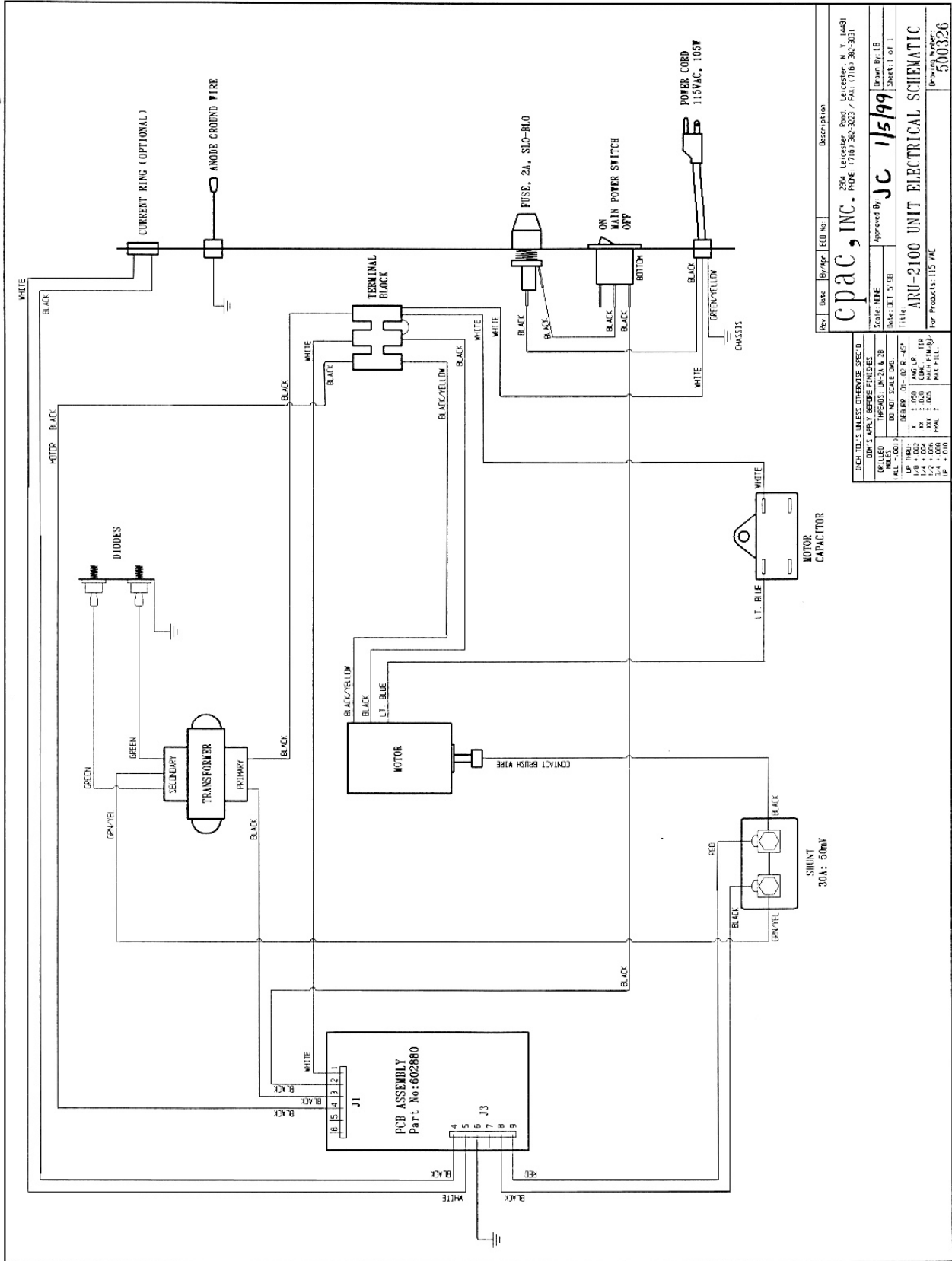

Per:	Date:	By:	ED No:	Description:
cpac, inc.				
2304 Leicester Road, Leicester, N. Y. 14881				
PHONE: (716) 382-3223 / FAX: (716) 382-2631				
Scale:	NO:	Approved By:	Date:	Drawn By:
1/16"	JC	JC	1/5/99	LB
Title: ARU-2100 UNIT ELECTRICAL SCHEMATIC				
Sheet 1 of 1				
For Products: 115 VAC				
Part No: 500326				

DRAWING IS UNLESS OTHERWISE SPEC'D	
UNLESS OTHERWISE SPEC'D	USE THE FOLLOWING DIMENSIONS
ALL DIMENSIONS	IN MILLIMETERS
ALL DIMENSIONS	TO BE TO NEAREST 0.025
ALL DIMENSIONS	TO BE TO NEAREST 0.001
ALL DIMENSIONS	TO BE TO NEAREST 0.0005
ALL DIMENSIONS	TO BE TO NEAREST 0.0002
ALL DIMENSIONS	TO BE TO NEAREST 0.0001
ALL DIMENSIONS	TO BE TO NEAREST 0.00005
ALL DIMENSIONS	TO BE TO NEAREST 0.00002
ALL DIMENSIONS	TO BE TO NEAREST 0.00001

- APPLICATION NOTES**
- Typical silver discharge at drain: .75 PPM to 3 PPM
 - Application Range: 2.5 gallons per day (24 hours)
 - Replace RePAC 10 cartridge every 300 gallons processed or every 6 months
 - Limit collection of silver on the cathode to 6-8 pounds
 - Clean out CT-5 tank and overflow fittings every 6 months

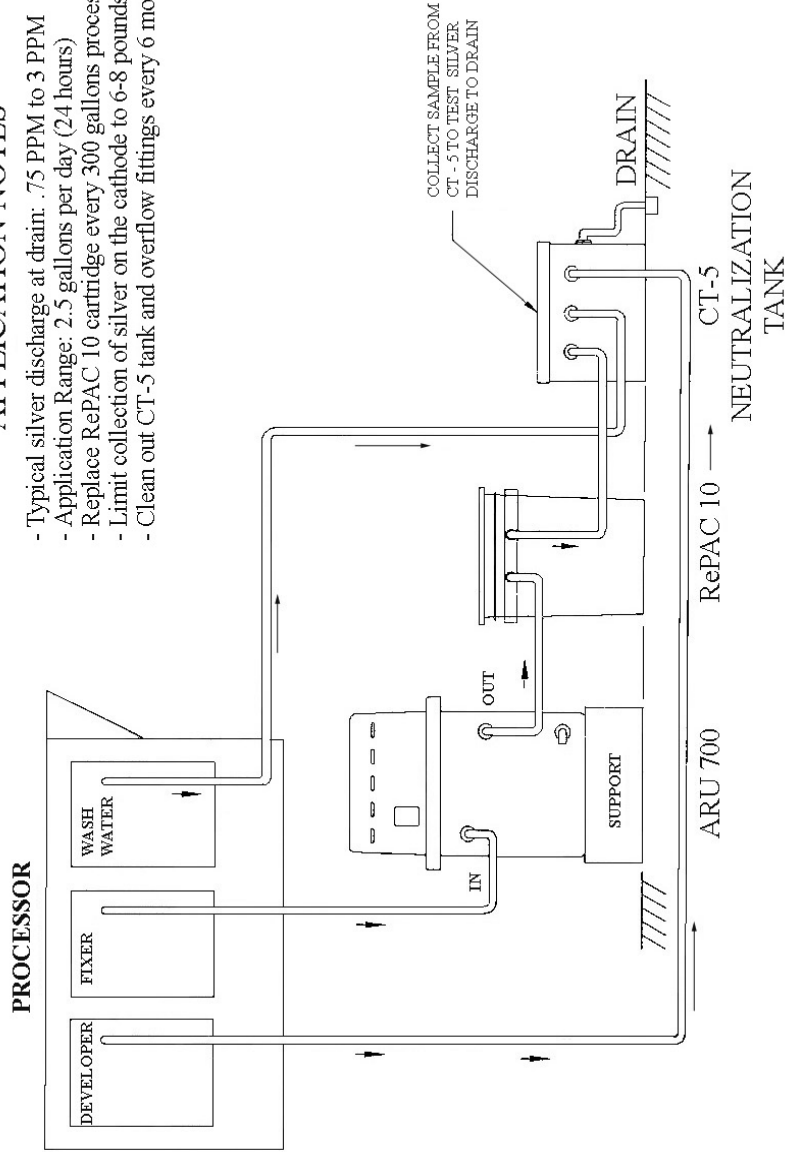

**ARU 700 APPLICATION/INSTALLATION
DRAWING 699978**

- APPLICATION NOTES**
- Typical silver discharge at drain: .75 PPM to 3 PPM
 - Application range: 4 gallons per day (24 hours)
 - Replace RePAC 10 cartridge every 300 gallons processed or every 6 months
 - Limit collection of silver on the cathode to 8-10 pounds
 - Clean out CT-5 tank and overflow fittings every 6 months

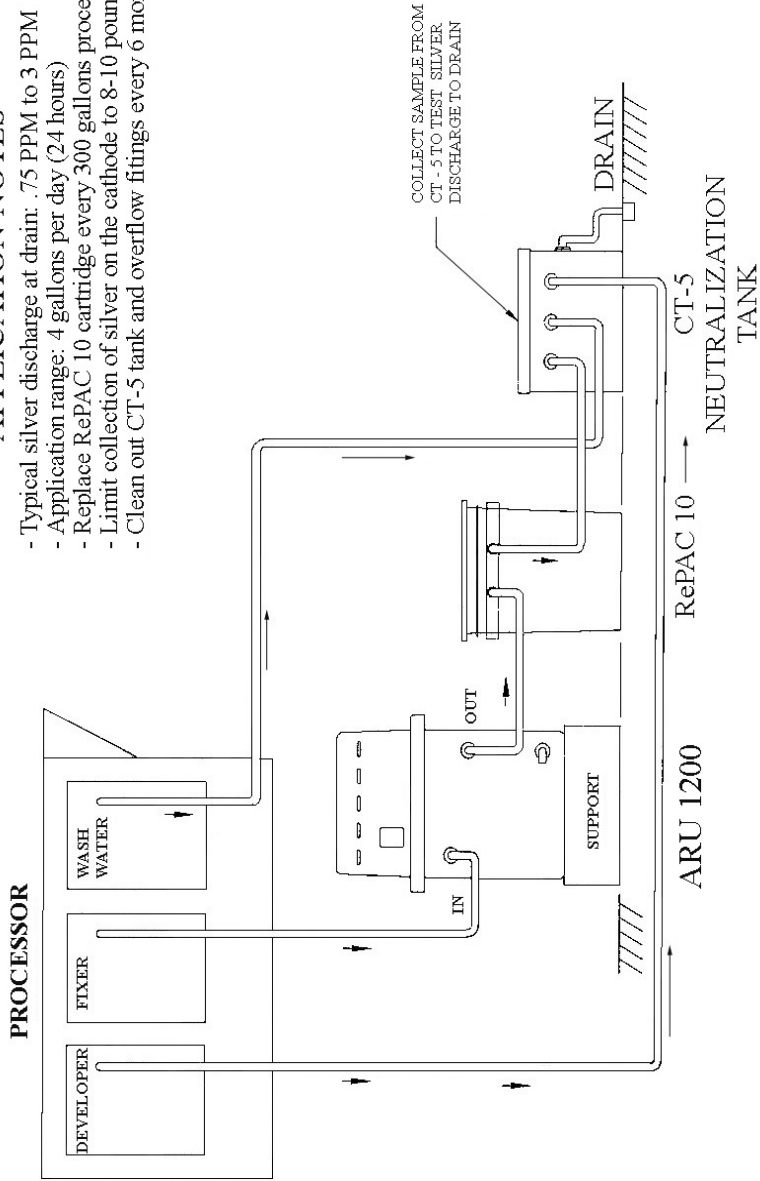

**ARU 1200 APPLICATION/INSTALLATION
DRAWING 69979**

- APPLICATION NOTES**
- Typical silver discharge at drain: .75 PPM to 3 PPM
 - Application range: 8 gallons per day (24 hours)
 - Replace RePAC 20 cartridge every 400 gallons processed or every 6 months
 - Limit collection of silver on the cathode to 10-12 pounds
 - Clean out CT-5 tank and overflow fittings every 6 months

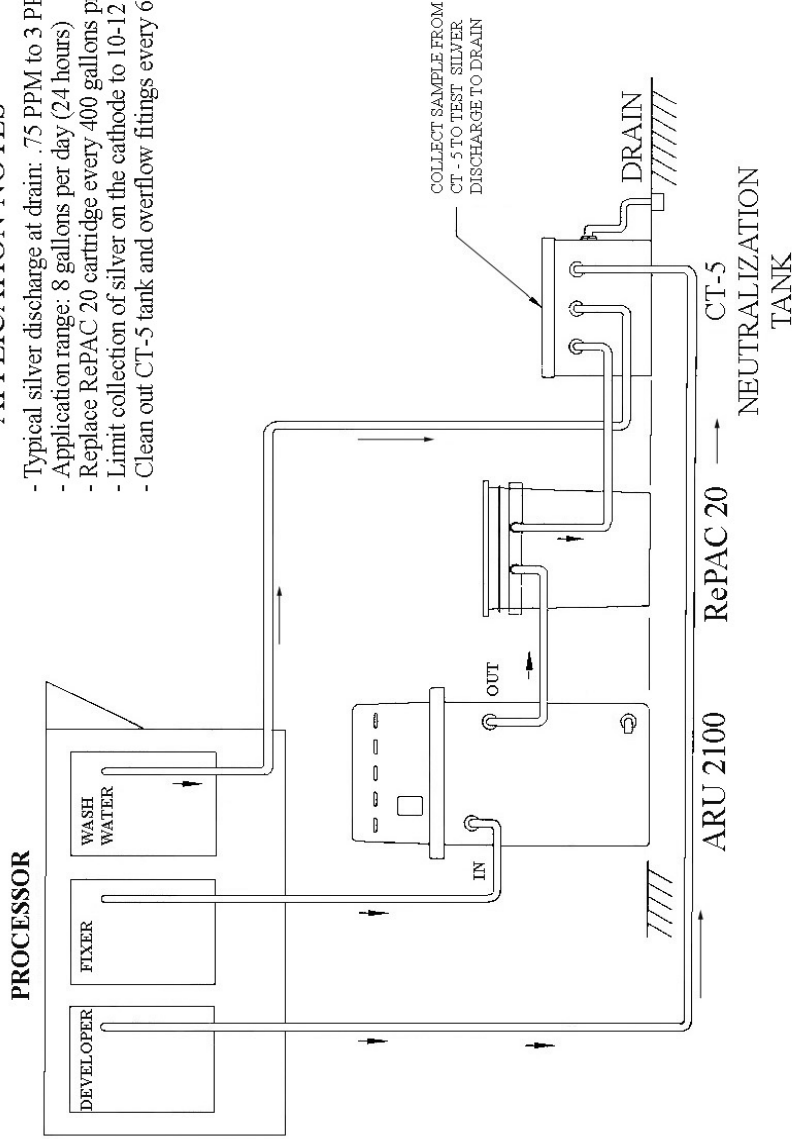

**ARU 2100 APPLICATION/INSTALLATION
DRAWING 699980**

ARU-700
(115/230 VAC, 50/60 Hz)

SPARE PARTS LIST

CPAC PART NO.	DESCRIPTION
602997	Motor Assy
28-107P2012	Diode, Rectifier
602880	PCB
701094	Fuse, 1A, Slo-Blo
703134	Transformer, plating
70-107A8028B	Anode
SP-124B8002	Cathode
603049	Brush Assy
05-139A9001D	Bearing, rulon
703191	Seal, teflon
SP-107M0099	Motor Coupling Kit (consisting of):
	(1) 09-107A9024B - Coupling, motor
	(1) 48-111P2012 - Set screw
	(1) 50-107P2040 - Washer, flat
SP-107M0033	Cathode Coupling Kit (consisting of):
	(1) 09-107A9044F - Shaft, drive
	(1) 51-107P2022 - Bolt, hex head
603027	Seal-Bearing Kit (consisting of):
	(1) 05-139A9001D - Bearing
	(1) 703191 - Seal
	(1) SP-107M0099 - Motor Coupling Kit
	(1) SP-107M0033 - Cathode Coupling Kit
	(1) 50-114A9092A - Load Washer

ARU-1200
(115/230 VAC, 50/60 Hz)

SPARE PARTS LIST

CPAC PART NO.	DESCRIPTION
602997	Motor Assy
28-107P2012	Diode, Rectifier
603007	PCB
700629	Fuse, 2A, Slo-Blo
703135	Transformer, plating
70-107A8028B	Anode
SP-107A8019	Cathode
603049	Brush Assy
05-139A9001D	Bearing, rulon
703191	Seal, teflon
SP-107M0099	Motor Coupling Kit (consisting of):
	(1) 09-107A9024B - Coupling, motor
	(1) 48-111P2012 - Set screw
	(1) 50-107P2040 - Washer, flat
SP-107M0033	Cathode Coupling Kit (consisting of):
	(1) 09-107A9044F - Shaft, drive
	(1) 51-107P2022 - Bolt, hex head
603027	Seal-Bearing Kit (consisting of):
	(1) 05-139A9001D - Bearing
	(1) 703191 - Seal
	(1) SP-107M0099 - Motor Coupling Kit
	(1) SP-107M0033 - Cathode Coupling Kit
	(1) 50-114A9092A - Load Washer

ARU-2100
(115/230 VAC, 50/60 Hz)

SPARE PARTS LIST

CPAC PART NO.	DESCRIPTION
602997	Motor Assy
28-107P2012	Diode, Rectifier
603008	PCB
700629	Fuse, 2A, Slo-Blo
703135	Transformer, plating
70-107A8029B	Anode
SP-107A8020	Cathode
603049	Brush Assy
05-139A9001D	Bearing, rulon
703191	Seal, teflon
SP-107M0099	Motor Coupling Kit (consisting of):
	(1) 09-107A9024B - Coupling, motor
	(1) 48-111P2012 - Set screw
	(1) 50-107P2040 - Washer, flat
SP-107M0033	Cathode Coupling Kit (consisting of):
	(1) 09-107A9044F - Shaft, drive
	(1) 51-107P2022 - Bolt, hex head
603027	Seal-Bearing Kit (consisting of):
	(1) 05-139A9001D - Bearing
	(1) 703191 - Seal
	(1) SP-107M0099 - Motor Coupling Kit
	(1) SP-107M0033 - Cathode Coupling Kit
	(1) 50-114A9092A - Load Washer

EVERY EFFORT HAS BEEN MADE TO INSURE THE COMPLETE ACCURACY OF THE CONTENTS OF THIS MANUAL. NO LIABILITY ARISING FROM ITS USE, HOWEVER, CAN BE ACCEPTED BY THE COMPANY, WHO RESERVES THE RIGHT, WITHOUT PRIOR NOTICE, TO ALTER THE SPECIFICATIONS, CONSTRUCTION, OR CONTENT OF ITS EQUIPMENT AT THE COMPANY'S OWN DISCRETION.

Statement of Warranty

All equipment is manufactured to exacting standards and has been tested and inspected for proper workmanship and performance before shipping.

Any parts which are defective will be repaired or replaced within a one year period after date of shipment, provided the equipment has been used according to the instruction manual and have not been abused or tampered with.

The company will not be responsible for any damage resulting from leakage of water or chemicals caused by improper installation, operator carelessness or defective/loose plumbing fittings associated with installation and operation of the equipment. The company assumes no responsibility for damage in transit and the customer should resent any claim for such damage to the carrier.

This warranty gives you specific legal rights. You may also have additional rights that vary from state to state.

Any unit to be repaired under warranty must be shipped, freight prepaid, or delivered to a facility authorized to render services provided hereunder. Returned unit must be either in its original package or a similar package affording an equal degree of protection. All units must have a Material Return Authorization code (MRA) visible on the returned item. MRA's can be obtained by calling 716-382-3223.